

Since 1968

COMMAX
SmartHome & Security

User Manual

Color Video Door Phone CDV-1024MA



www.commax.com

COMMAX Co.,Ltd.



- Thank you for purchasing COMMAX products.
- Please carefully read this User's Guide (in particular, precautions for safety) before using a product and follow instructions to use a product exactly.
- The company is not responsible for any safety accidents caused by abnormal operation of the product.



Greetings

- Thank you for choosing COMMAX.
- Please read this manual carefully before you use the product.



Table of contents

Greetings	1
Table of contents	1
1. Warnings and caution	2
2. Parts Names	4
3. How to use the product	5
4. How to install	22
5. Installation diagram	23
6. Wiring diagram	24
7. Package contents	25
8. Specifications	26
9. Safe operation guide	26



1. Warnings and caution

Please follow the things described below in order to prevent any danger or property damage.

Warning
It may cause a serious damage or injury if violated.

Caution
It may cause a minor damage or injury if violated.

- Prohibition.
- No disassembly
- No touch
- Must follow strictly.
- Shows plugging out the power cord without an exception
- Shows the warning and caution for an electric shock.
- Shows the warning and caution for a fire.

Warning

Power & Installation

Please don't use several products at the same time on one power socket.
· It may cause a fire due to an abnormal overheating.

Please don't bend the power cable excessively or it may cause an electric shock.
· fire when using a damaged power cable.

Please don't handle the power cable with a wet hand.
· It may cause an electric shock.

Please plug out the power cable from the socket when not using it for a long period of time.
· It may shorten the product lifespan or cause a fire.

Please don't install the product in the place where there is much oil, smoke or humidity.
· It may cause an electric shock or fire.

Please don't install the product with the lightning and thunder.
· It may cause an electric shock or fire.

Please don't use and connect this product with other products with different rated voltage
· It may cause a disorder or fire.

When installing the product that generates heat, please install the product away from the wall (10cm) for the ventilation.
· It may cause a fire due to the increased internal temperature.

! Warning

Cleaning & Use

Please don't disassemble, repair or rebuild this product arbitrarily (please contact the service center if a repair is needed).

- It may cause an electric shock or fire.



If an abnormal sound, burning smell or smoke is coming out of the product, please plug out the power cable and contact a service center.

- It may cause an electric shock or fire.



Please don't insert any metallic or burnable materials into the ventilation hole.

- It may cause an electric shock or fire.



Please use only the designated batteries for the products of using DC power.

- It may cause an electric shock or fire.



! Caution

Power & Installation

Please plug the power cable firmly into the inner end

- It may cause a fire.

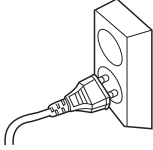

Please hold the plug tightly when unplugging the power cable (a part of the copper wire may be disconnected if the grabbing is only made on the cord when pulling out the cable).

- It may cause an electric shock or fire



When connecting the power cables after cutting the cable, please install the product with power off

- It may cause an electric shock or fire



When installing the product, please fix it firmly while using the wall-mounting unit and screws.

- It may cause an injury from the falling object.

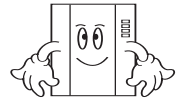

Please be careful when using an AC circuit breaker since there is a possibility of an electric shock.

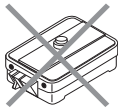

Please check the use voltage and current for the DC-only products and use the appropriate rectifier.

- It may cause a fire.



Please avoid direct rays of the sun or heating devices at a time of installation.

- It may cause a fire.

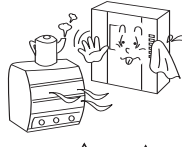

Please don't install the product on an unstable place or small support board.

- It may cause an injury if it falls down while in use.



Cleaning & Use

When cleaning the product, please rub it with a soft and dry cloth after plugging out the power cable. (Please don't use any chemical products such as wax, benzene, alcohol or cleanser.)



Please don't drop the product on the ground and don't apply a shock.

- It may cause a failure.

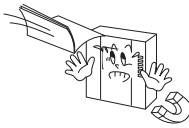

Please use the designated connection cable within the maximum calling distance designated for the product

- It may reduce the product performance.





2. Parts Names

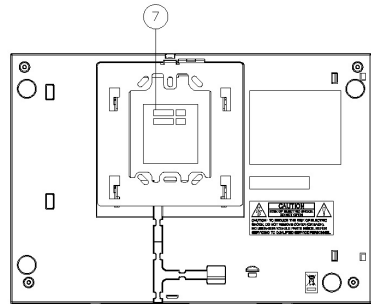
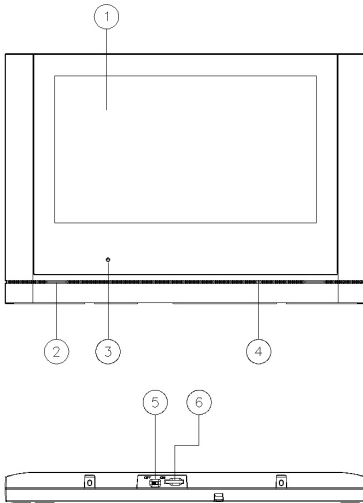

No	Parts	No.	Parts	No.	Parts
1	Touch LCD	2	Speaker	3	Power LED
4	Microphone	5	Power switch	6	Micro SD card slot
7	Connection terminal				



3. How to use the product

3-1 Main screen



No.	Menu	Details
1	Monitor	View the door camera - You cannot use it if door camera is not connected
2	CCTV	Monitoring CCTV - You cannot use it if CCTV is not connected
3	Interphone	Move to Interphone menu
4	Playback	Move to the list of recorded images and videos
5	Security	Move to Security menu.
6	Option	Move to the menu 'Options'
7	Mute Icon	Indication of mute status
8	Date & Time	Indication of Date and Time, Touch to move to the menu 'Set-up'

* Cautions

- Please set up date and time before use.
 . If you do not set up, some problems in saving still-cut image and video-clip might happen.
- When some monitors reboot for any reason, other monitors which are connecting can be stopped for normal operation.

3-2 Monitor

- The following screen will be shown when calling from door camera or touching the button 'Monitor'.
- The below screen will last for 30 seconds.
- Monitoring is not available in case of no connection of the door camera.
- When you use a one monitor, you cannot use other monitors for monitoring/ CCTV/ Interphone.

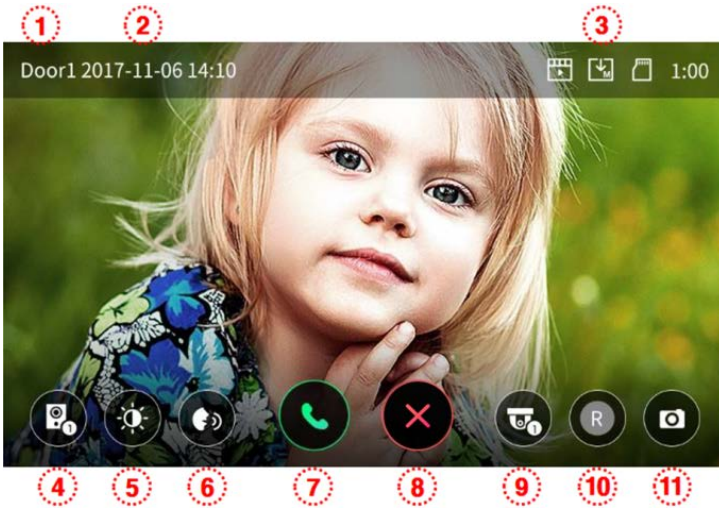

- ① Selected camera: Selected camera will be shown on the screen.
- ② Date & Time: Current date and time will be indicated.
- ③ Storage (Saving) icons: Icons for motion detection and recording will be indicated.

- Details of icons



Storage format: Images / Videos (In Motion detection mode)



Storage mode: MANUAL / AUTO



SD card status: Insertion / Full memory

- ④ Split screen view: Split monitoring of door cameras is available.
It's not available to use if there is only one camera installed.
- ⑤ Video quality adjustment: Door camera Display setting
 - Brightness/ Luminosity / Chroma adjustment is available after pushing the button.
 - The range for adjustment is 0-20. There is a button located on the right upper for initialization.



- ⑥ Volume control: You can control calling tone volume and receiving tone volume.
- Push the button in order to adjust the volume.
 - Volume adjustment level: Ring (0-3), Speaker (1-3)



- ⑦ Call connection: To call & answer the call.
- After call is connected, 7 & 8 buttons will be changed as follows.



Door open (No.7): To open the door.



End call (No.8): To end a call.

*** Cautions**

If you set 'Fast mode' in the menu option 'Open door mode', there will be shown only 'Door open' icon. In this case, opening door is possible only.

- ⑧ Call cancellation: To cancel the call when you get a call from door or lobby.
- ⑨ CCTV monitoring : To check CCTV video during call or monitoring.
(If CCTV is not connected, the icon is not displayed.)
- ⑩ Video-clip storage (saving): To store (save) a video-clip.
- When you touch a button, you can store a video-clip.
(When you set an auto-storage mode, a video-clip is automatically stored)
 - Max 90 seconds per one storage (Call connection 30 seconds + Calling 60 seconds)
 - The below icon will be shown during storage, and the remaining time will be shown on the right upper.



-If you want to stop storage, you should touch the icon.

- ⑪ Image (Still-cut image) storage: To store (save) a still-cut image.
- When you touch a button, you can store images. And the below icon will be shown during storage.



***Calling of visitor**

- ① When a visitor calls from entrance, you can hear calling tone(sound) and the visitor's image appears on the monitor.
- Max 30 seconds for call connection time.

- When you set an auto-storage mode, video-clip and image are automatically Stored.
- ② When you touch a call connection button, you can talk to a visitor. And when you touch a door-open button, the door will be opened.
 - Max 60 seconds for calling time.
 - While a video-clip is being stored, you can re-store a video-clip for 60 seconds from call-connecting moment.
 - You can open the door when the screen is on. And, it is possible only when door camera is interlocked with door release function.



- When you touch a door-open button, the below door-open icon will be shown in the center of screen. But door-open sound will not work during video-clip and image storage.
- ③ When the other call comes from the other entrance, the current call is finished and the other call is connected.
- ④ When you press a call-end button, the call is end. And the main screen will be shown.

* Calling of additional monitors

- ① In case of more than 2 monitors, when a visitor calls from door camera (entrance), a calling tone(sound) will be ringed in all monitors. And a visitor's image will be shown in all monitors.
 - Max 30 seconds for call connection time.
- ② When one monitor connects with door camera, the main screen (4-1) will be shown in other monitors. And Monitoring, CCTV, Interphone buttons of other monitors will be deactivated.
- ③ When you touch a door-open button after calling, the door will be opened.
 - Max 60 seconds for calling time.
 - You can open the door when the screen is on.
- ④ When you press a call-end button, the call is end. And the main screen will be shown.
 - And then, Monitoring, CCTV and Interphone buttons of other monitors will be activated.
- ⑤ When you touch a call connection button at additional monitors (ID2/ID3/ID4), the master monitor (ID1) will stop any of operating functions (Saving of images/video-clips, etc.,) and will display the main screen.

3-3 CCTV

- When you touch a CCTV button, the below screen will be shown.
- Monitoring time is Max 60 seconds
- You can save the video-clip within monitoring time.
- You cannot use CCTV functions if cameras are not installed.
- When you use a one monitor, you cannot use other monitors for monitoring/ CCTV/ Interphone.

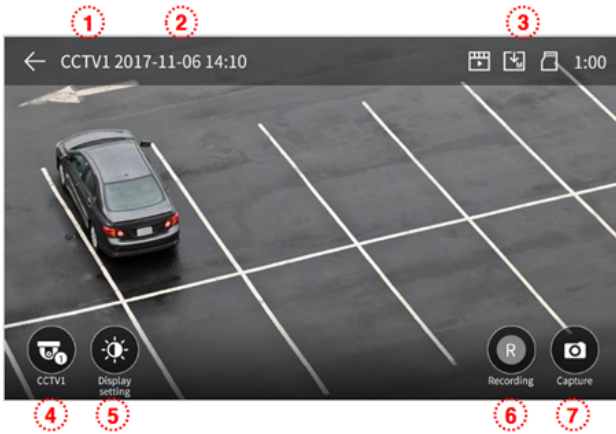

- ① CCTV sign: To show the current working CCTV.
- ② Date&Time: Current date and time will be indicated.
- ③ Icon set: To show motion detection and video storage.(Monitor section for more details)
- ④ CCTV screen change: To see CCTV 1 screen and CCTV 2 screen.
 - You cannot use this function when only one camera is connected.
- ⑤ Video quality adjustment: To change Brightness/Light & Shade/Chroma. of CCTV
(Monitor section for more details)
- ⑥ Video storage: To store (save) a video-clip.
 - When you touch a button, the storage will be started.
 - The below icon will be shown during image storage. And the remaining time will be shown on the right upper.



-If you want to stop storage, you should touch the icon.

- ⑦ Image storage: To store (save) a still-cut image.
 - When you touch a button, you can store images. And the below icon will be shown during storage.



*** Reference(Door camera and CCTV are same in the below issues.)**

- ① Video-clip cannot be stored while SD card is not inserted.
 - The images can be stored in the monitor's embedded memory. (Max 50 images).
 - You can use as below when you need back-up of images which are stored in the monitor's embedded memory.
 - 1) Turn off the monitor and then insert SD card. Turn on the monitor. And then the images are automatically stored in SD card.
(After a backup, files will be automatically deleted.)
 - 2) You can check the file through your computer. ([backup folder] in SD card)
 - 3) You can check the date, storage time and information (camera source, saving format, emergency storage).
 - File name: YYYYMMDD_HHMMSS_AB.AVI or JPG
 - Note : The meaning of the last two digits (denoted by AB)
 - A : 1 - DOOR1 / 2 - DOOR2 / 3 - CCTV1 / 4 - CCTV2
 - B : 1 - MANUAL(manual recording)/2 - AUTO/3 - MOTION/4-Always monitoring / 5 - ALARM
 - ex : The meaning of the file '180109_045740_12.avi'
 - > Video automatically recorded by visitors calling from door1 on January 9, 2018 at 4:57:40
- ② The image and video-clip can be stored while SD card is inserted. The maximum storage size depends on the capacity (storage size) of SD card.

3-4 Interphone[=Extension monitors : Master monitor & Slave monitors]

- **When you touch Interphone button, the below screen will be shown.**
- **When you use a one monitor, you cannot use other monitors for monitoring/ CCTV/ Interphone.**

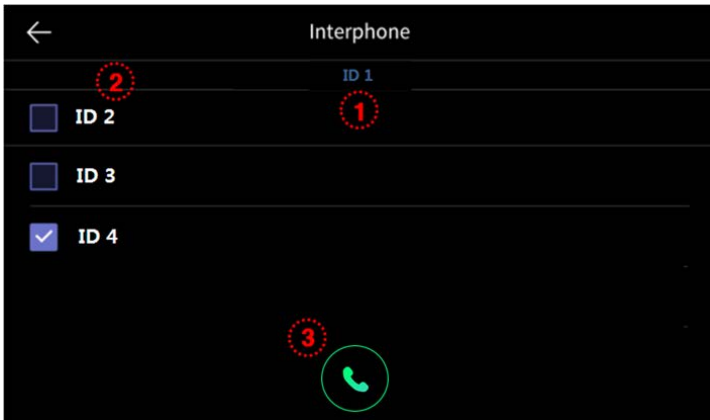

- ① ID sign : To show my current interphone ID.

- ② Interphone selection : To select an interphone which I want to connect.
(duplicate/double selections are possible)
- ③ Call connection: To call and answer a selected interphone.

- After you select an interphone and touch a call connection button in the above screen, a new screen in the next page will be shown and calling tone (sound) from the selected interphone will be ringed.
- The simultaneous call connections to all interphones are possible, and the mutual calling among interphones are possible.
- The button of unselected interphones will be deactivated during the mutual calling between selected interphones. And, main screen will be shown for unselected interphones during the mutual calling between selected interphones.
- Interphone's screen of sending call connection.

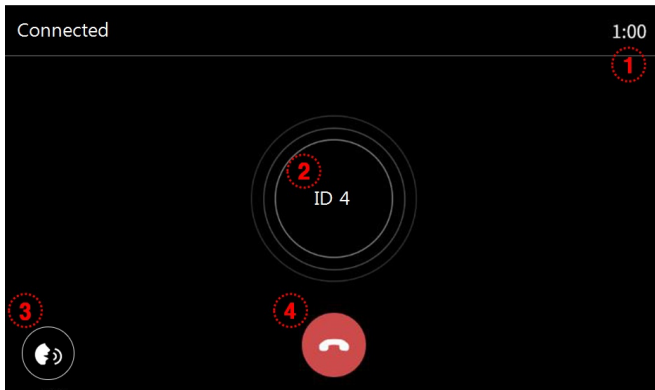

- ① Call connection & Calling time :
 - To show remaining call connection time and remaining calling time.
 - Max 30 seconds for call connection.
 - Max 60 seconds for calling time (In case of receiving call connections from all interphones, the calling time will be calculated from the latest call connection for 60 seconds).
- ② The other party's ID sign : To show the other party's ID.
 - When you call more than 2 interphones, all IDs will be shown on the screen.
- ③ Volume control : To control receiving volume (1-3 level).
- ④ Call end : To finish call connection and calling.

- Interphone's screen of receiving call connection.

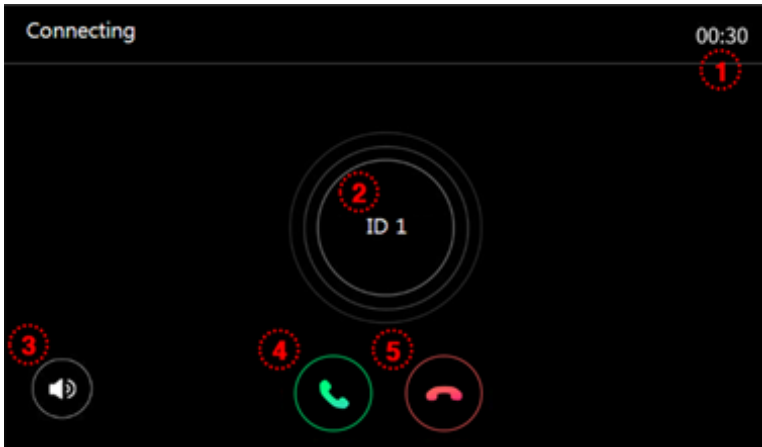

- ① Call connection & Calling time :
To show remaining call connection time and remaining calling time.
- Max 30 seconds for call connection.
- Max 60 seconds for calling time. (In case of call connections from all interphones, the calling time will be calculated from the late call connection for 60 seconds)
- ② The other party's ID sign : To show the other party's ID.
- ③ Volume control : To control calling volume.(0-3 level)
- It will be changed to the button for receiving tone volume after starting calling.
- ④ Call connection: To connect call.
- ⑤ Call end : To finish call connection and calling.

3-5 Playback

- When you touch Playback button, the below screen will be shown.
- Select the image. (Selected image will be enlarged and video will be displayed.)

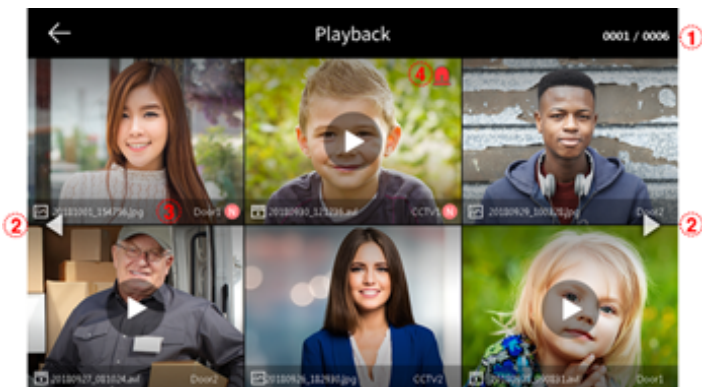

- ① Page information : Current page / Total page
- ② Move the page: ◀ : previous page / ▶ : next page
- ③ File information

 :Image file,  : Video file,  : New file

- ④ Emergency Recording: File saved when emergency occurs by sensors.
 - When 'Auto Rec' is set in Security menu, CCTV video is recorded for 10 secs when emergency occurs. (CCTV1 is automatically saved when sensor # 1 is detected and CCTV2 is saved by sensor # 2. But, if there is no SD card inserted, only steel cut image is saved and the sensor need to be connect to CCTV.)
 - If visitor call is received during emergency, the video of visitor will be saved automatically on 'Auto Recording' setting or also can be saved manually. (During emergency situation, the visitor communication is restricted and only the visitor image can be checked.)

- To verify images.



- ① Storage source & file No.
- ② Left/Right movement : To move the previous/next file.
- ③ Date &Time : Current date and time will be indicated.
- ④ Delete files: To delete images.

- To verify video-clip.

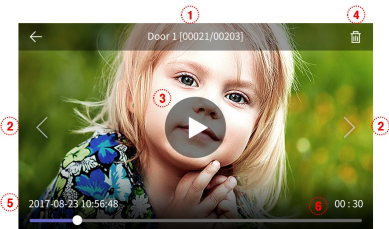

- ① Storage source & file No.
- ② Left/Right movement: To move the previous/next file.
- ③ Playing the file: To play the current video-clip.
 - During playback, the icon is changed by the pause button.
- ④ Delete the file: To delete the current playing file.
- ⑤ Date & Time: Current date and time will be indicated.
- ⑥ Video-clip time indication: The remaining time is displayed



<Note>

Immediately after inserting SD card, the loading time depends on the number of stored file size.
If you press Playback button before loading completes, pop-up window will appear.
In this case, please wait a moment.

3-6. Security (Can be used with security sensor)

- Touch the Security button to display the following screen.
- Using this function, the door is detected when the sensor is connected.
- This function setting (On and Off/ save video / log view) is possible only by ID1 (MASTER device).
(In case of extension phone (ID2 ~ ID4), only the alarm rings.)

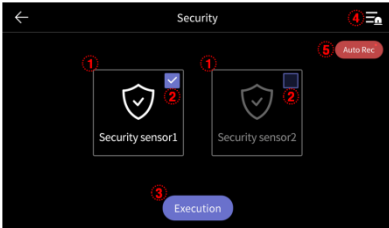

< Before operation >

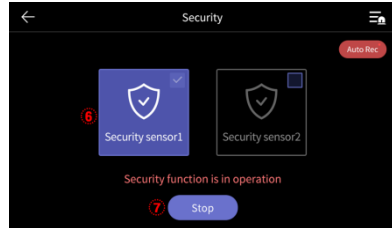

< During Operation >

1) Before operating Security mode

※ Caution

Be aware of the password before proceeding.

You cannot turn off the alarm if you don't know current password. (Factory default : 1234)

- ① Security Sensor 1, Security Sensor 2: Select sensor to operate.
- ② Select check box : If the sensor is selected by check box. (Turn on & Turn off)
- ③ Execute button: Activate the selected sensor. (Please note that the alarm occurs when sensor is detected)
- ④ Emergency log : You can check emergency log. (Up to 255 log can be stored)
- ⑤ Auto recording: CCTV is automatically recorded for 10 seconds when an emergency occurs.
 - When the function is active (red), the corresponding function is activated. (You can turn off it by click.)
 - CCTV1 is recorded in case of sensor 1 emergency, and CCTV2 is automatically recorded in case of sensor 2.
 (If there is no SD card, it will be replaced with steel cut image. If CCTV is not connected to the sensor, it will not be recorded.)
- 2) During Security mode : The LED light of MASTER unit is flickering on red.
- ⑥ Indicates the security sensor being executed.
- ⑦ End the security function.
 - Press the button and enter the four-digit password. (Factory default password: 1234)
 - If the password is correct, the mode is turned off and the screen returns to the main screen.
 - (If the password is incorrect, you can not turn the mode and please progress initialization of the device.)

<<Password input screen to turn off the mode>>

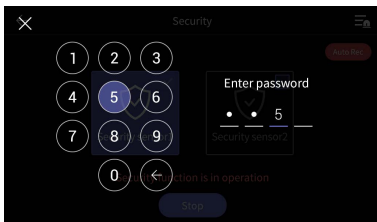

<Sensor detected screen during security mode>



3) When security alarm occurs

- When a sensor is detected during security mode, an alarm is generated, and the sensor number (Sensor1 or Sensor2) and the time of occurrence are displayed.
- If the emergency situation is canceled, press 'Stop' button at the bottom.
(You can turn off the alarm if the corresponding sensor is recovered to normal status.)
- When the password input window appears, enter the four-digit password using the key buttons.
- Alarm sound occurs for 3 minutes and then only alarm screen is displayed after then.
- If an alarm occurs, it will not be possible to communicate with visitor even if the call is received. Please turn off the alarm first.
- (During the alarm occurs, the calling sound rings by the camera to indicate the emergency situation.)

3-7 Option

- When you touch option button, the below screen will be shown.
- When you select each item, the corresponding sub item is displayed on the right.
- If you do not do any action for 30 seconds after you get in Option menu, the main screen will be shown.

① Recording

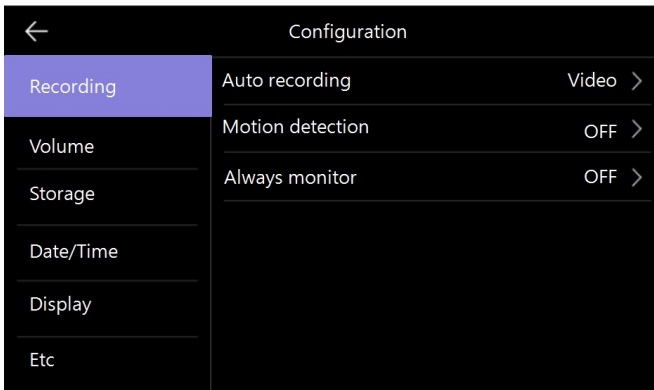

1) Auto recording

- To set the auto save mode. (Select between Photo / Video)
However, if there is no SD card, video mode cannot be selected.
(If video is selected when SD card is removed, it is replaced with photo and saved in internal memory)
- This function is only available when a call comes from a door camera (entrance).And you cannot save photos and video-clip manually until the automatic saving is started.
- Selecting OFF disables the auto save function.

2) Motion detection : Can be used only with ID1 (MASTER)

- To set motion detection of the previously set camera.
- Functions of each menu are as following.

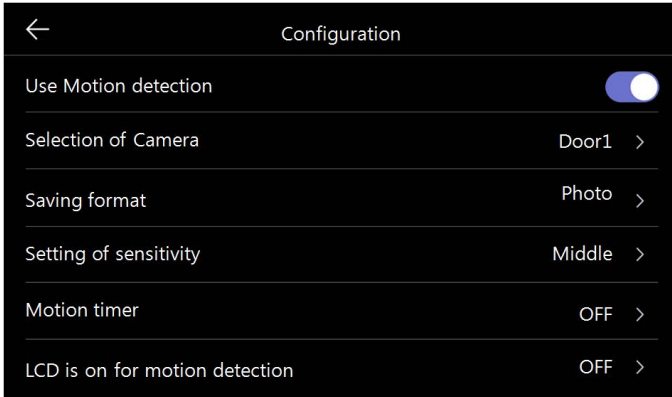

- Motion detection: To set enable / disable function.
- Selection of Camera: To select camera for monitoring. (Select from Door1/2, CCTV1/2)
- Saving format: To select storage method.(Select between Photo / Video)
- Sensing of sensitivity: To set sensitivity.(Select among High / Middle / Low)
- Motion timer: To setup the timer function activation.(Motion detection activation time)
- LCD is on for motion detection : During video recording, it shows video on LCD. (for 10 seconds)

Once activated, you can set the timer, start / end time.

* Reference

- When detecting motion, the photo is saved for 1 scene and the video-clip is saved for 10 seconds.
- The LED is flickering during the saving of the video-clip. And, when you touch the screen, the saving is stopped.
- After saving, the front LED stops blinking, and the motion detection is started within 3 seconds.
- This function can be set / used only for an Interphone (monitor) set to master. (ID 1)
- In the night or dark place, the LED of door camera is always on while this function is working.

3) Always monitor : Can be used only in ID1 (MASTER)

- Always-on monitoring and video saving can be possible. (When the call is receiving, the operation will be terminated automatically)
- DOOR1 -> DOOR2 -> CCTV1 -> CCTV2 -> DOOR1... Operated in order.
- If there is an SD card, the movie will be saved at the same time. Without SD card, the photo is saved.
 - ① 10 seconds per camera : Video saving and monitoring changes every 10 seconds.
 - ② 30 seconds per camera : Video saving and monitoring changes every 30 seconds.
 - ③ 60 seconds per camera : Video saving and monitoring changes every 60 seconds.

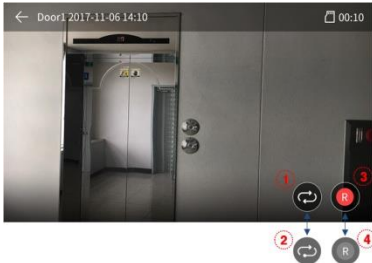

< 1. SD card inserted >



< 2. SD card not inserted >

1. If SD card is inserted: Video recording starts at the same time as monitoring.

- ① : The camera is changed every set time (CAM1 -> CAM2 -> CCTV1 -> CCTV2 in order)
- ② : Press the icon to change, the current camera will be fixed and monitored.
- ③ : Save the video. (it will be recorded repeatedly even if the camera is changed).
- ④ : Press the icon to change. Repeat monitoring without saving the video.

2. If the SD card is not inserted: The monitoring is changed every set time and the image is saved automatically once.

- ⑤ : Click the icon to save the image once more.

(During saving the image, the icon is temporarily changed and displayed.)

② Volume

Configuration	
Recording	Volume >
Volume	Touch tone ON >
Storage	Interphone calling tone sound1 >
Date/Time	Door1 calling tone sound2 >
Display	Door2 calling tone sound4 >
Etc	

1) Volume

- When individual door camera (entrance) and intercom calls, you can change the calling tone and receiving tone individually.
- You can change the calling tone from 0 (mute) to 3 level and the receiving tone from 1 to 3 level.

2) Touch tone

- To turn on / off the touch tone.

3) Interphone, Door1, Door2 calling tone

- You can select calling tone of interphone and individual door camera. (Door1, Door2)
- 6 types of calling tones are available.

③ Storage

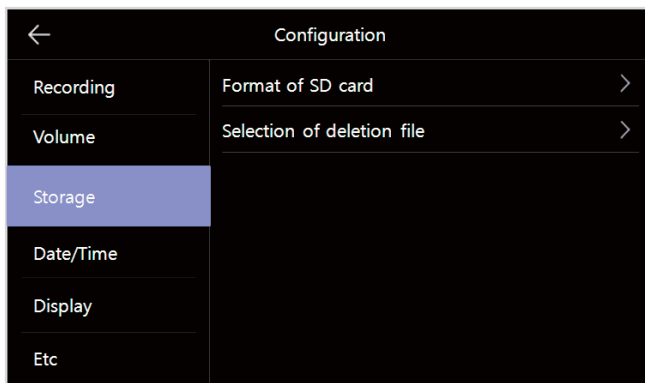

1) Format of SD card

- To initialize the SD card.
- It takes about 1 min. for initialization.
(It can be different by types of SD card).

2) Selection of deletion file

- To delete the saved images and videos.
- The time required varies depending on the file size.

* Cautions

- It is not available to receive a call while initializing SD card or deleting saved files.
- If you start initialization of SD card, it is not possible to stop it.
In case of inevitable ending initialization, it is necessary to start again from the beginning.

④ Date/Time

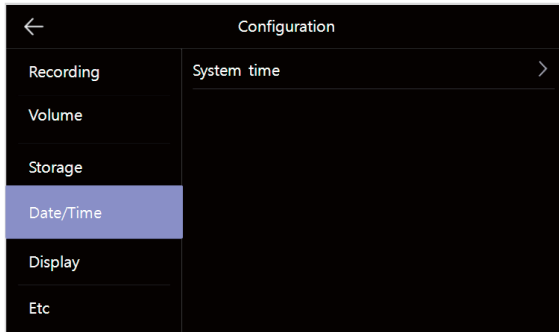

1) System time

- To Set-up Date and Time.
- The changed time will be displayed on the main screen afterward.

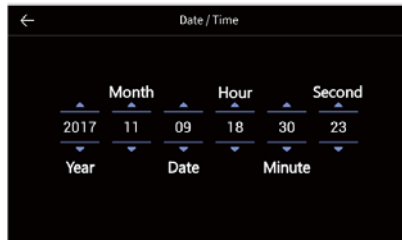

⑤ Display

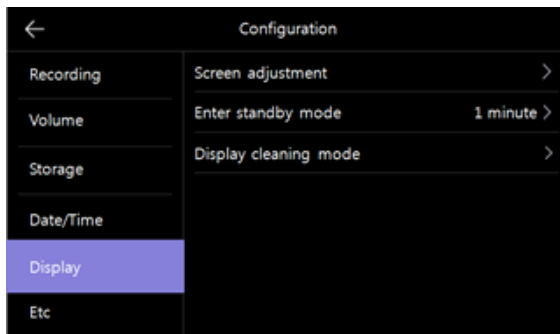

1) Screen adjustment

(In this case, you can adjust the display of door camera1.)

- When you use a one monitor, you cannot use other monitors for monitoring/ CCTV/ Interphone.
- The range for adjustment is 0-20 level. There is a button located on the right upper for initialization.



2) Enter stand-by mode

- To set up stand-by mode.

If you do not do any action during the setting time, the monitor shows stand-by mode

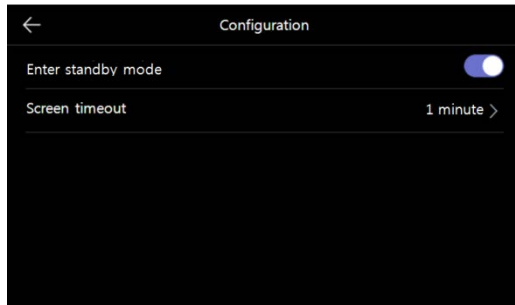

-Enter standby mode : To set up a time to activate stand-by mode

(If you deactivate the set-up time, it automatically sets up with 30 seconds.)

- Screen timeout: To set amount of time for stand-by mode. (Select among 1/2/3 minutes)

3) Display cleaning mode

- When selecting 'Cleaning mode', the touch screen is deactivated for 30 seconds.

(You cannot stop this function until it is finished.)

⑤ Etc

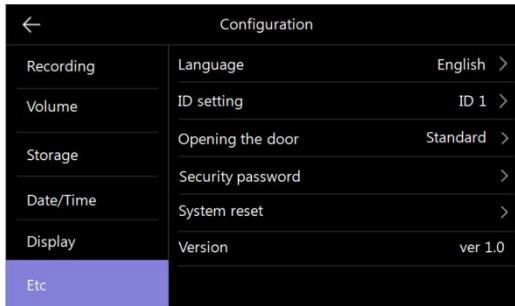

1) Language

- To select the languages.(8 languages)

한국어	English	русский
español	简体中文	Język polski
Türkçe	Čeština	

2) ID setting

- In case of installing more than 2 monitors, ID setting is required for inter-communication.
- The product set to ID 1 will operated as a master, and individual camera, CCTV and sensors should be connected to the master.

*Cautions

- Please check the duplication of each ID.
The monitors might operate abnormally in case of ID duplication.

3) Opening the door

- To set up door-opening method.
Standard: To open the door during calling.
Fast: To open the door during calling.

4) Security password: It can be set and used only in ID1 (MASTER)

- Set the password (4 digits) to be used to disable the security mode or to dismiss the alarm
1. Enter password :

Press the button and enter the four-digit password in order using the number key generated.

(Initial value: 1234) (If you lose the password you are using, you can restore to the default value [1234] by executint System reset),

2. Password reset: If the password is correct, the corresponding input window will be generated.

- New password: Enter the new password.
- Confirm password: Press the new password again.
(This is to prevent the wrong password being entered)

3. If the two passwords are different, an alert window will appear. Please input again

4. If they are same, the 'apply' button will be activated. Pressing the button will change the password.

* If you do not want to change during the input, please click the 'X' tab in the top left corner

5) System reset

- To proceed with initialization.

6) Version

- To display the current program version.

* Reference (SD card information)

1) Available SD card

- SDHC / SDXC: MAX 256 GBytes (Class 10 or higher)

2) FORMAT (File system) method: FAT32 (Boot the product after inserting a formatted SD card at first use)

3) Maximum storage capacity

- When SD Memory Card is not connected: Only 50 images can be saved (Embeded

memory) - When connected to SD card: Can store up to 10000 images / movies

(However, if the storage file size is large, the maximum quantity may be reduced)

	Micro SD Card		
Capacity	8 GBytes	64 GBytes	256 GBytes(MAX)
Video (Max 90 secs)	80 Cuts	700 Cuts	2800 Cuts

<Number of movies can be saved by 90 seconds VIDEO >

* Precautions on using Micro SD Cards

- 1) Please, do not turn on/off, insert or remove Micro SD card during playing, saving or formatting and so on. It might be caused of malfunction, harm or damage goods.
- 2) When the saving capacity of Image is over, then it automatically deletes the oldest Image and saving the newest Image instead.
- 3) The capacity of video file may vary depending on the environment being stored
- 4) If memory is full, when you are saving old files may be deleted.
(Please back up your data when FULL icon is displayed.)
- 5) If you use a bad micro SD card, you may experience problems with your product
- 6) Since the number of storable time (storage cycle) varies depending on the memory type of the SD card (T-flash), check the memory type before use.

<Note: Number of storable time by memory type>

SLC memory> MLC memory> TLC memory



4. How to install

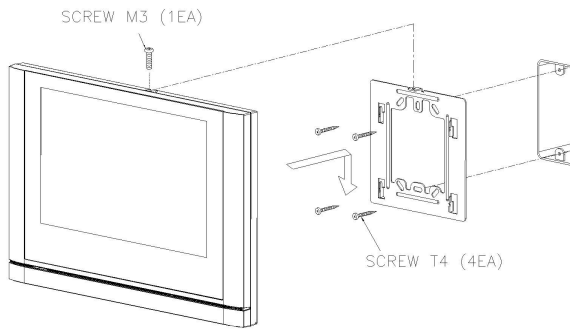

Note

- Avoid installing the product in the area of direct sunlight.
- The position of the unit's body should fit the standard height range.
(Recommended height range is 1450 ~ 1500mm)
- Avoid installing the product exposed to gas exposure, magnetic force, in humid temperatures, as it may damage the condition and performance of the product.



5. Installation diagram

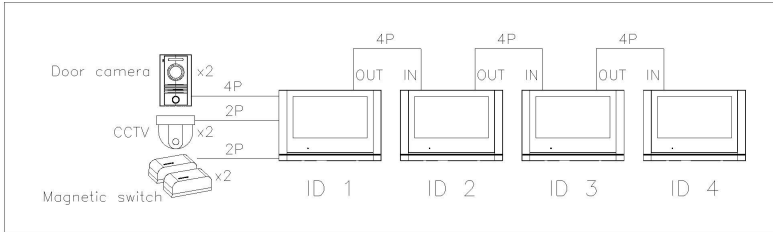

Note:

1. Individual door camera (entrance) and CCTV must be connected to the master monitor (ID 1), and master monitor must be installed at the first stage.
2. Be careful not to change IN / OUT wiring.

6. Wiring diagram

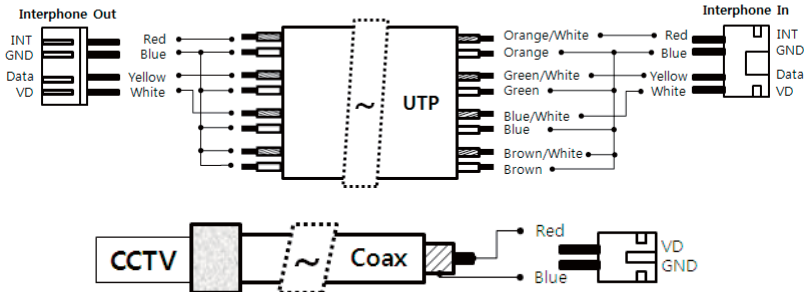
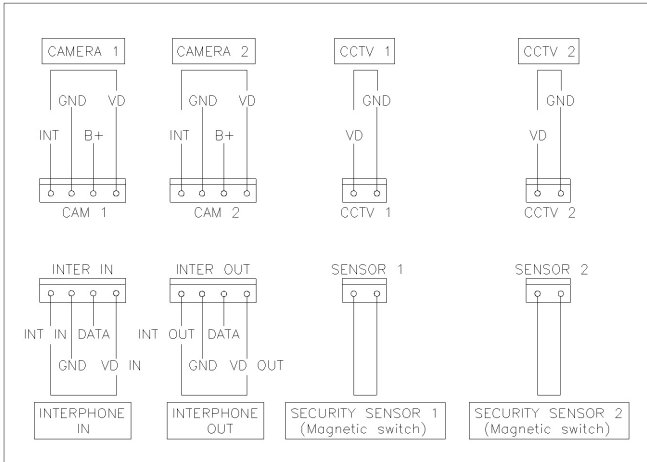

Note:

1. In case, if there is a high-voltage power line in the area of installation, use metal tube coaxial cable for wiring.
2. Beware of wrinkling of line coating and cable stick-outs as it may cause circuit shortage and operation inconvenience.
3. When connecting a monitor with a camera, make sure power switch is turned off.

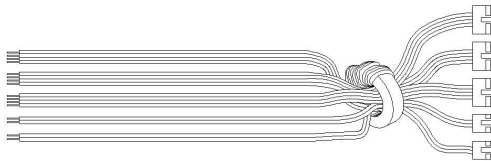

When wiring(Camera, CCTV, Interphone, sensor), please use the core provided in the package to wrap around as shown in the above.



7. Package contents

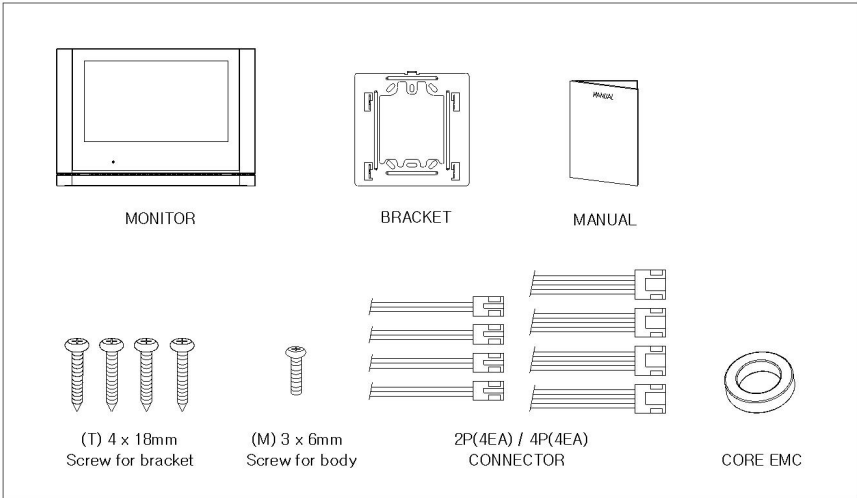

① Monitor(CDV-1024MA).....	1EA
② Wall bracket for monitor	1EA
③ User Manual	1EA
④ Wall bracket mounting screw	4EA
⑤ Monitor fixing screw	1EA
⑥ Connector 2P.....	4EA
Connector 4P.....	4EA
⑦ CORE EMC OR29*7.5-19H	1EA

* Connecting Device

Door Camera / CCTV : AHD camera (up to 2 Megapixel)



8. Specifications

Model	CDV-1024MA		
Transmission Method	Camera 4 wire (polarity), CCTV 2 wire (polarity), Sensor 2 wires(non polarity) Household unit(monitor) expansion port4 wire (polarity)		
Power Source	100V-240V~, 50/60Hz		
Consumption	Stand-by : 3.5 W Max : 18.5 W		
Intercom system	HANDS FREE type (Voice switch circuit)		
Monitor	10.1" FULL TOUCH LCD		
Video subscription time	Individual door camera call connection / monitoring: 30 ±5sec Calling: 60 ±5sec Interphone call connection: 30 ±5sec / Calling: 60 ±5sec		
Wiring Distance	UTP CAT 5e. Standard	Camera /CCTV <-> (ID 1)	Household unit (monitor) <-
		Household unit (monitor)	>Household unit (monitor)
		28 meters (MAX)	15 meters (MAX)
		Resistance under 10Ω per 100 meters on UTP Cat 5e	
Operating Temp.	0 ~ +40°C (32°F ~ 104°F)		

* Connectable camera : DRC-4CPHD2 (2M pixel)



9. Safe operation guide

- Make sure to turn on the product.
- In case if physical damage or operation failure is detected, do not hesitate to contact Service Center.
- All electric power must be blocked by the building blocking device.
- Do not place water bottles or flowerpots upon the product.
- Please, turn the power off when installing or repairing the product.

COMMAX

COMMAX Co.,Ltd.

513-11, Sangdaewon-dong, Jungwon-gu, Seongnam-si, Gyeonggi-do, Korea
Int'l Business Dept. Tel. : +82-31-7393-540~550 Fax. : +82-31-745-2133
Web site : www.commax.com

Edited, 2019, 12, 30

Printed In Korea / 2016.06.104