

Installation Guide

LH1000/LH2000 Hotel Lock

Version: 1.2

Date: Aug. 2013

Introduction:

This document will explain to the customers about how to use LH1000/LH2000 hotel lock. If you want to know how to install our hotel lock, please check "LH1000/LH2000 Hotel lock installation guide".

Notices

Privacy warning:

First of all, thank you very much for choosing this product! For the fear of doing some unnecessary damage to this product, please read our specification carefully before you using it! Our company kindly remind you that, the right way of using it will provide you faster speed of verification and usage results.

No part of this document may be reproduced or transmitted in any form or by any means without prior written consent of ZKTeco Inc..

Direction for using this documentation:

Because the continuing updates of this product, our company does not guarantee this document will be consistent with actual product, we also do not be liable for the dispute caused by the difference between actual and document technical parameters. In case of any dispute, ZKTeco's decision shall be final and conclusive.

Before using this product, the following staffs must read the contents in below which correspond to themselves.

- ◆ Managers of the system
- ◆ Installer and configurator

Catalogue

1. Recommendation of tools	1
2. Accessories' introduction	2
3. Installation procedure	3
3.1 Install Caution.....	4
3.2 Installation Steps.....	5
4. Notice for use.....	14
4.1 Appearance introduction.....	14
4.1.1 Foreplate aggregation introduction	14
4.1.2 Backboard aggregation introduction	14
4.2 How to use emergency key.....	15
4.3 Battery low voltage protect function	16
4.4 Software management	16

1. Recommendation of tools



1) hammer



2) screwdriver



3) woodworking chisel



5) Cable drilling tool



7) abrader



6) tapper



8) riveting gun



9) carpenter pencil



10) pliers

2. Accessories' introduction

1	lock body	12	4 set screws
2	4 cross recess wood screws	13	Battery (4 No.5 alkaline batteries)
3	Plaque?	14	battery holder aggregation?
4	2 cross recess countersunk head screws	15	backboard aggregation?
5	mechanical locking head	16	double lock square shaft?
6	2 Hex socket screws (tapered ned)	17	IC/ID card
7	Door catch board ?	18	CD
8	Door catch box?	19	Drill template
9	2 square shafts	20	hex wrench
10	foreplate aggregation?	21	snap-lids sucker?
11	key		

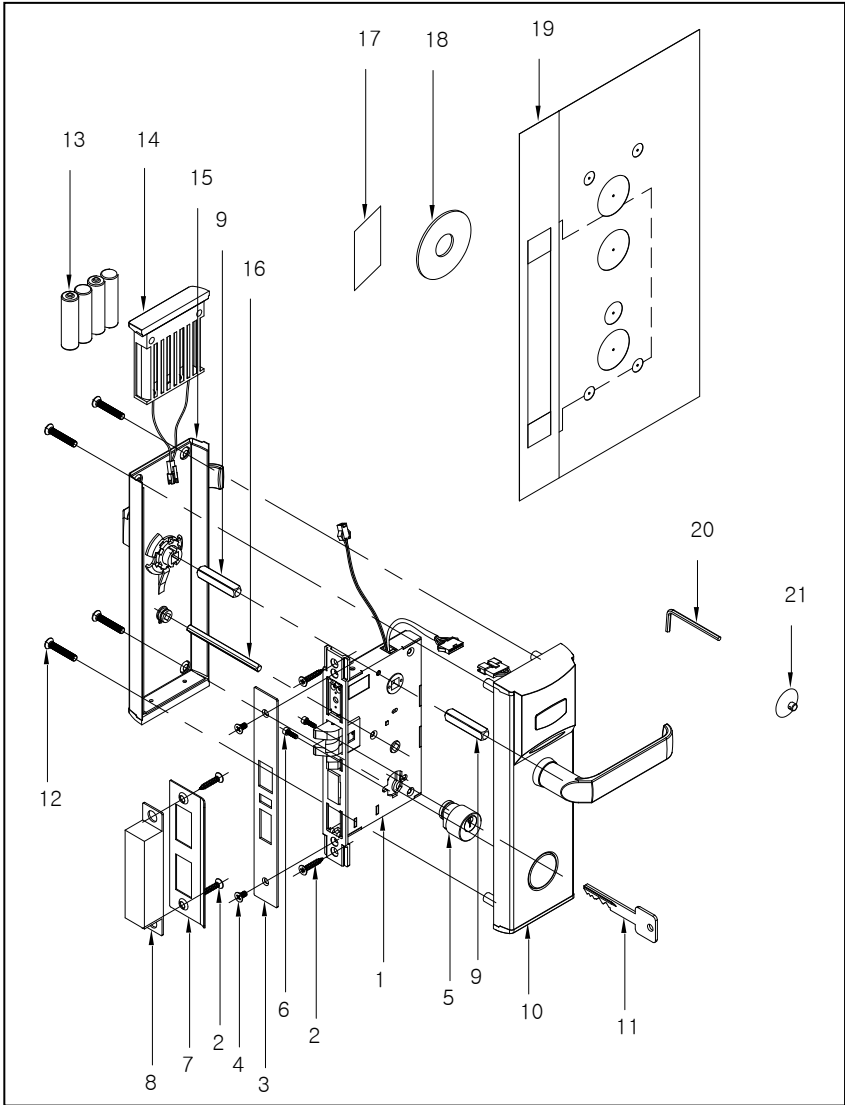

3. Installation procedure

3.1 Install Caution

(1) this lock is fit for the boors which thickness is between 35~50mm, if doors' thickness is beyond the range, please inform us before you make your order.

(2) when you install this lock, lock's central point must 1 meter away from the ground.

(3) please confirm the way you want open the door and lock body's position. There are 4 ways you can open the door: Left inward、left outward、right inward、right outward, if a person stand outside the door, door's axle on this person's left side means this door is left open , on right side means right open , if this person need open the door by pushing it, then it is inward door , need open the door by pulling, then it is outward door. Show as Figure 1

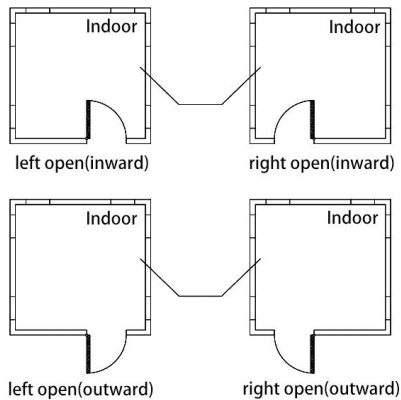

Figure 1

3.2 Installation Steps

1) after confirmed the lock's position and height, put the hole making drill template on right position, then, drew a central point on punching point at the front of door. Show as Figure 1.

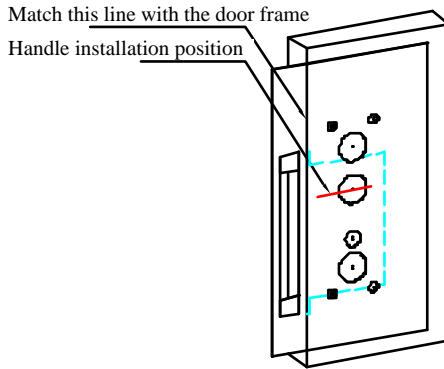

Figure 1

2) draw the lock body's insert port at the relative height on the side of the door, and make sure the insert port is in the middle of thickness of door. Show as figure 2.

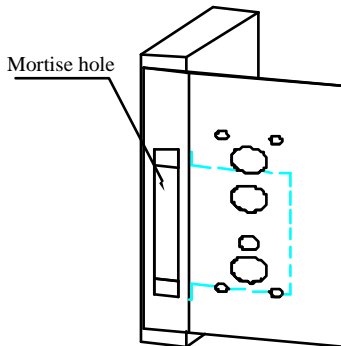

Figure 2

3) drill the relative hole at the front of the door. Show as Figure 3.

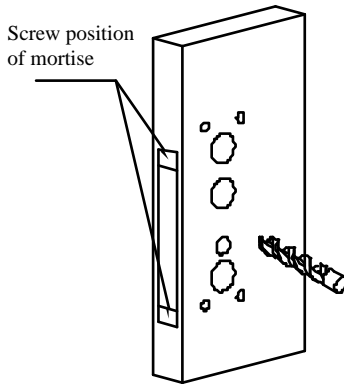

Figure 3

4) We suggest you can use 20mm drill, drill 93~95mm's hole when you drill lock body's insert port(makes next step easier).Warning: don't break the lock body's screw position. Show as Figure 4.

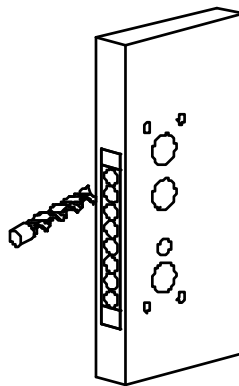

Figure 4

5) Use hammer and woodworking chisel dig the lock body's insert hole, deep about 93-95mm. show as Figure 5.

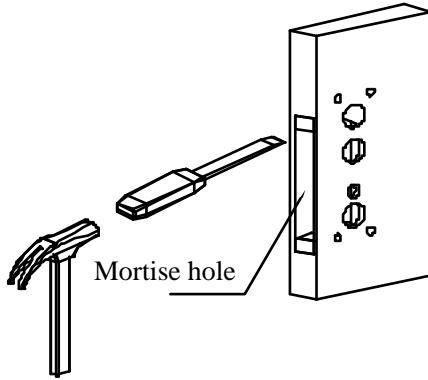

Figure 5

- 6) Use hammer and woodworking chisel dig the lock body's screw position deep about 6mm. Show as Figure 6.

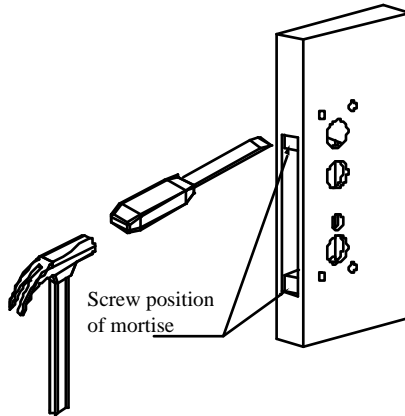

Figure 6

- 7) insert the lock body. Show as Figure 7.

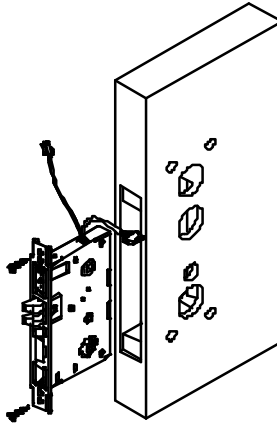

Figure 7

8) Put lock body's connecting wires and plugs out through the hole, show as figure, tighten 2 cross recess wood screws in to fix the lock body. Show as Figure 8.

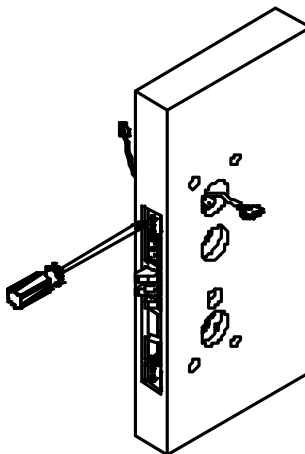

Figure 8

9) install the plaque. Show as figure 9.

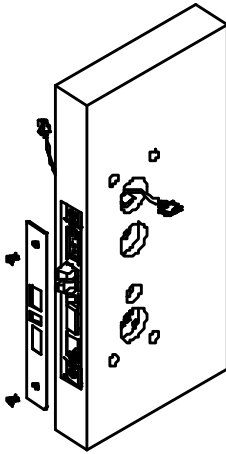

Figure 9

10) Tighten 2 cross recess countersunk head screws in. Show as Figure 10.

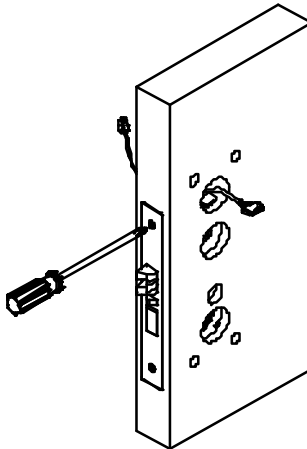

Figure 10

11) Install the locking head, locking head must be installed from outside, then use hex wrench tight 2 hex socket screws inside the door. Show as Figure 11.

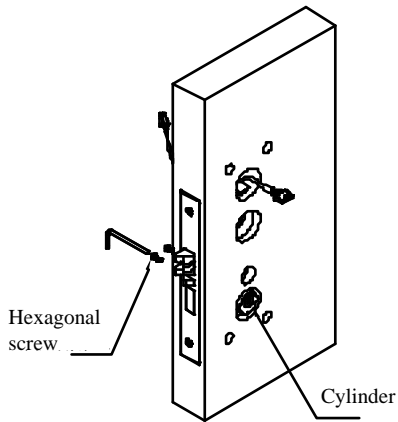

Figure 11

12) Install the handle's square shaft into the lock body's square hole, put the foreplat near the installation area, then stack the lock body's connecting wire's plug into the foreplat aggregation's socket. Show as the Figure 12.

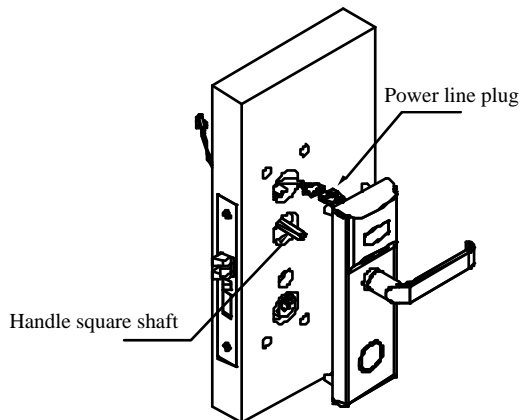

Figure 12

13) After the connection done, put the plug and wire into the door's round hole, then make sure the foreplat is adjoined to door. Show as Figure 13.

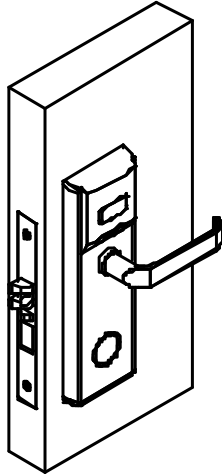

Figure 13

14) Install handle square shaft and double lock square shaft into the lock body's square holes, put the backboard near the installation area, then foist handle and double lock's shaft into handle and double lock button. Show as Figure 14.

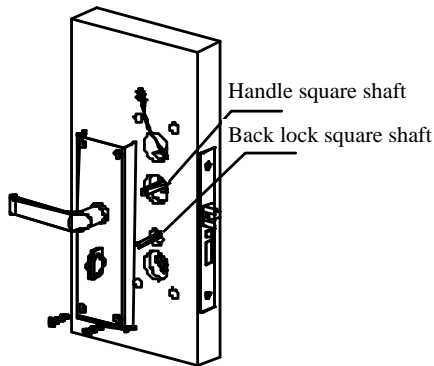

Figure 14

15) Adjoin door and backboard together, use screwdriver screw 2 set screws on bot of backboard but do not tight them. Show as Figure 15.

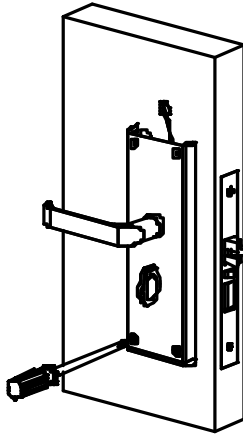

Figure 15

16) Install batteries into battery box, combine wire's plug and battery box together, then, put the battery box into the lock body. Show as Figure 16.

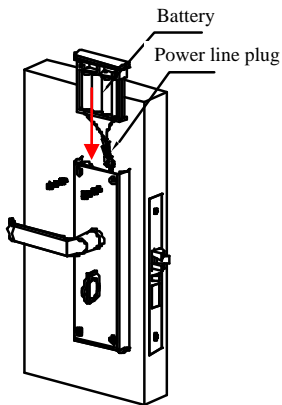

Figure 16

17) After put battery box into the lock body, tighten all 4 set screws on backboard. Show as Figure 17.

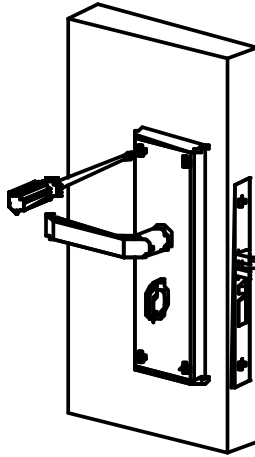

Figure 17

18) Drill holes and dig a slot at installed lock's location, install door catch board and door catch box on it then tighten the cross recess wood screws. Show as Figure 18.

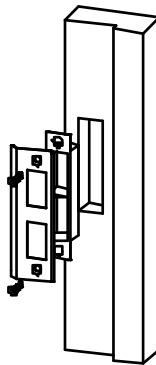

Figure 18

4. Notice for use

4.1 Appearance introduction

4.1.1 Foreplate aggregation introduction

Card swiping area / status light: when user swiping his/her card, card should close to the swiping area and stop in front this area until success. Swap proximity card can awake hibernate lock; If lock is proper functioning, the LED will flash as green; Operation failure will make LED flash as red for 3 seconds; Successful operation will make LED flash as green for 3 seconds. Show as Figure 1.

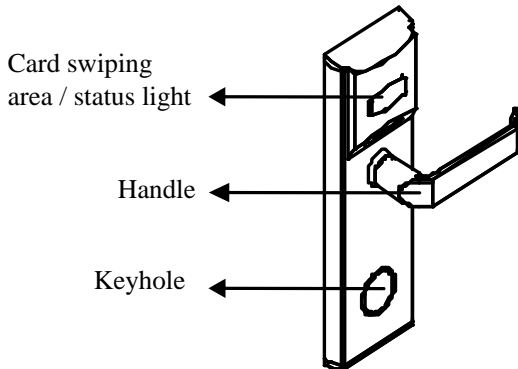

Figure 1

4.1.2 Backboard aggregation introduction

Use screwdriver screw out 2 upper set screws on backboard aggregation, pull out the battery box, then batteries can be taking out. Show as Figure 2 and Figure 3

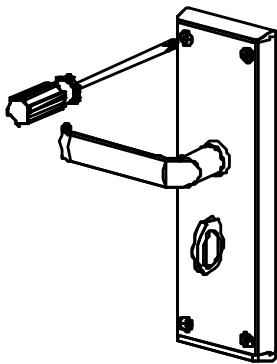

Figure 2

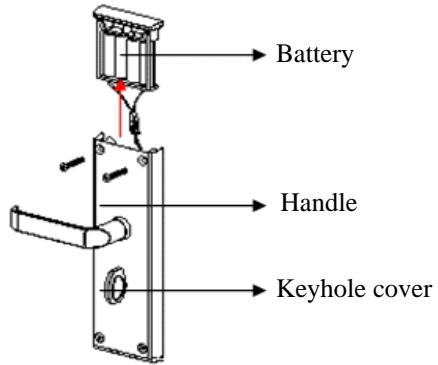

Figure 3

4.2 How to use emergency key

If you lost your proximity card, you can use emergency key to open the door.

- 1) Press the snap-lids sucker, you can take the snap-lids out. Show as Figure

1

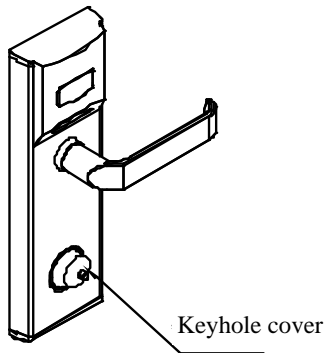

Figure 1

- 2) put the key in and clockwise rotation 90°, then you can open the door. Counterclockwise 90°, you can double lock the door. Show as Figure1.

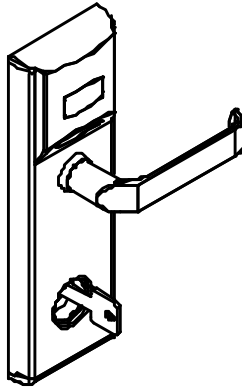

Figure 2

4.3 Battery low voltage protect function

Low voltage protect: when battery capacity is low, the lock will scale beeps and LED flash as red to remind user to renew the battery.



Notice: Don't use same batteries for a long time, please replace your batteries semiannually. Leakage may damage lock's circuit. Don't use low quality battery.

4.4 Software management

This lock will use software to control the user cards. Read more on accompanying software instruction book, include: enroll, delete, edit user.